

INSTALLATION INSTRUCTIONS

MORRIS CONTOUR/QUANTUM HIGH-RATE SIDE
BAND GRANULAR OPENERS



2110 Park Avenue Brandon, Manitoba, Canada R7B 0R9

Website: www.atomjet.com

Email: agriculture@atomjet.com

Phone: 1.204.728.8590

Fax: 1.204.726.5734

Toll Free: 1.800.573.5048

IMPORTANT WARRANTY/GUARANTEE INFORMATION

DO NOT DESTROY

Any claims under the guarantee must be COMPLETED BY OCTOBER 31 IN THE YEAR OF PURCHASE to qualify for a full refund. To satisfy a claim, Atom-Jet Industries must be given the opportunity during the seeding season to rectify the problem or issue, if NOT THE GUARANTEE IS NULL AND VOID. Wear under normal use is not covered by warranty/guarantee.

To activate your warranty registration, scan this QR code using the application on your mobile device and fill out the online form. Upon receipt of the completed form, we will send you a free pair of Atom-Jet work gloves.



WARRANTY IS TO BE COMPLETED BY OCTOBER 31 IN THE YEAR OF PURCHASE. The openers will either be Replaced or Repaired during this period. If you need to return an opener for warranty, please enclose your name, the farm name, address, phone number with area code, dealer purchased from, number of openers purchased, and the date of purchase. Please enclose copy of original invoice. Inclusion of the information will significantly speed up your warranty claim.



Before You Start

Our openers are designed to be compatible with all Morris Contour 1, Contour 2, and Quantum drills. Do not modify your openers to mount to your drill. See the diagram below to see which mounting holes to use on your drill.

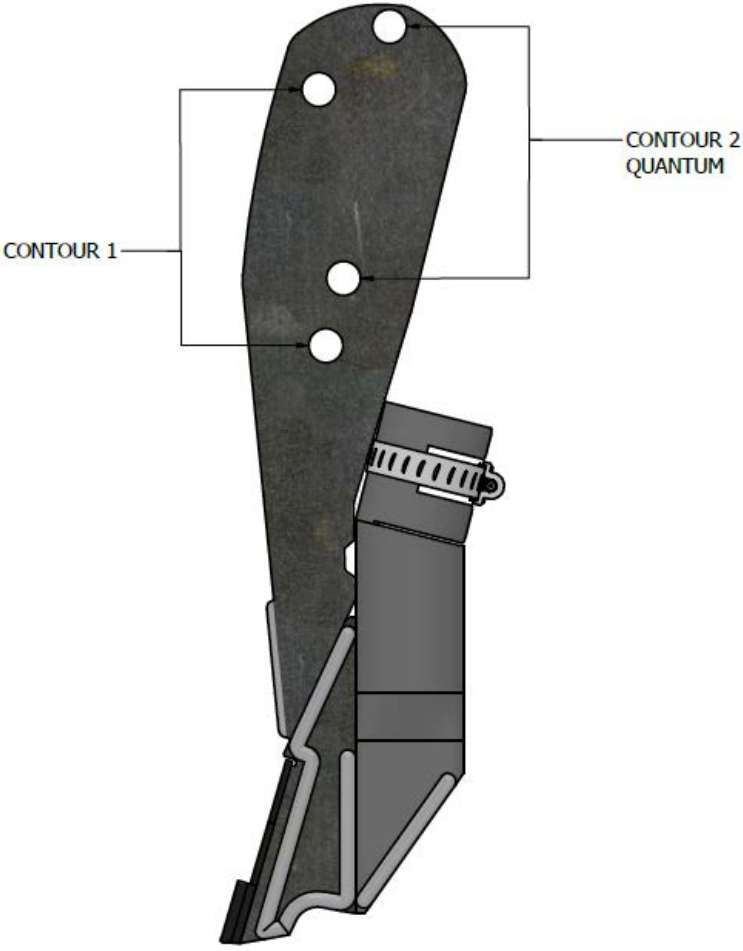

Figure 1: Mounting hole diagram

Note: All diagrams in this instruction set are shown on the Contour 2 shank.

Opener Installation

- 1) Bolt openers to shank using the supplied $\frac{1}{2}$ " x $1 \frac{7}{8}$ " bolts and nuts. You may need to use a screwdriver or a pry bar to open the shank to mount the opener. Install the openers with the stainless steel chute pointed to the center of the drill (see Figure 3).

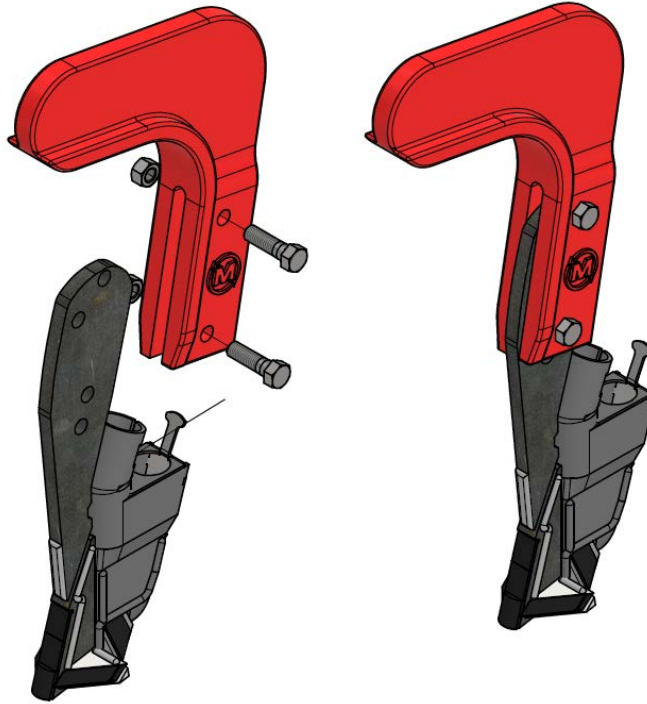

Figure 2: Bolt opener to shank

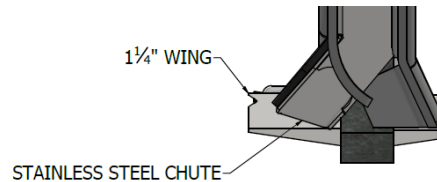
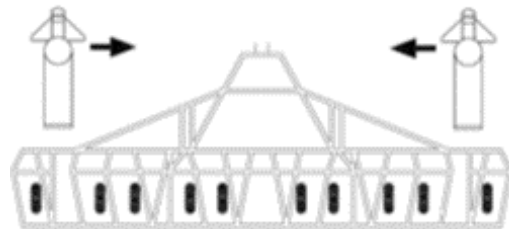

Figure 3: Left opener from the back

Mounting your openers on the correct side of the drill will reduce the chances of plugging while turning with the drill in the ground. A "left" opener will have the stainless steel chute pointed to the left when viewed from the back. In Figure 4, the arrows show the direction of the stainless steel chute.

Right opener is mounted on the left side of the drill



Left opener is mounted on the right side of the drill

Figure 4: Opener orientation

Atom-Jet high-rate side band granular openers can deliver seed through either port. This is a producer decision based on soil conditions, weather factors, and equipment packer configurations. Consider your options before installing hoses.

- 2) Insert the front dry hose into the front tube to where the opener narrows. Secure the tube with a #20 hose clamp.

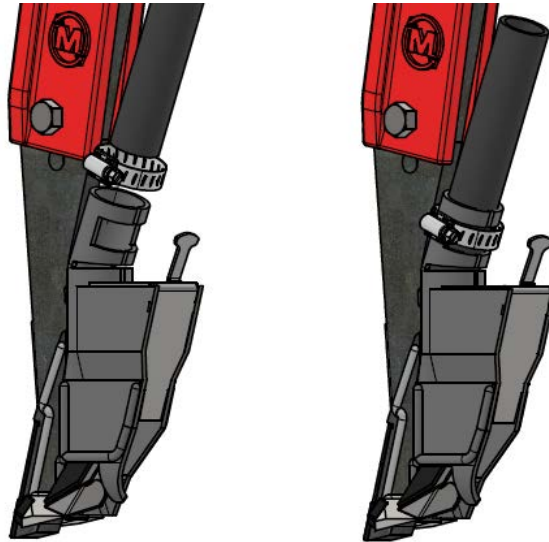

Figure 5: Install front dry hose

- 3) Remove the knock outs from the stainless steel cover and bend the tab up. Install the rear dry tube and secure with a #20 hose clamp.

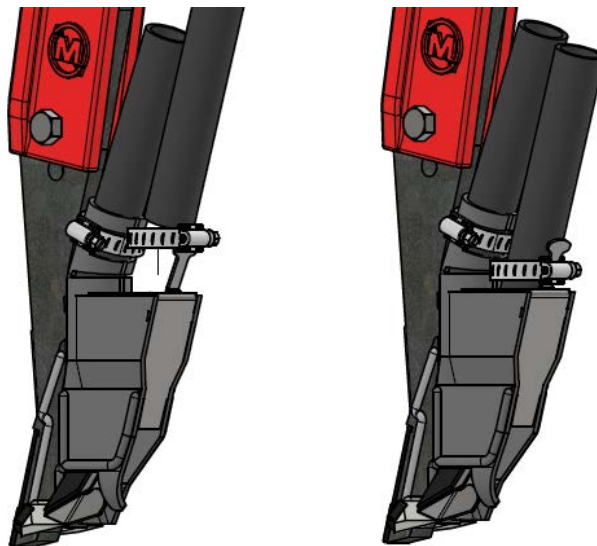

Figure 6: Install rear dry hose

Our openers are designed to allow hoses of different diameters. Hose bushings will be required for $\frac{3}{4}$ " ID hoses. Short pieces of delivery hose sliced vertically and slipped over the delivery hose make good bushings. If desired, a bushing can be purchased through Atom-Jet: part OP-CB15 TUBE SPACER.

Opener Maintenance

Atom-Jet openers are designed to be tough, durable, and reliable in all soil conditions. To extend the life of your openers even further, follow these steps:

- 1) Exchange openers from the wheel tracks with other areas of the drill or cultivator.
- 2) Maintain hard surfacing on the openers by building up the areas that were hard surfaced at the factory. Detailed instructions on how to do this are on the back page. Hard surface welding sticks and hard surface wire can be purchased through your local welding supply store.
- 3) Carbide protected wings for side band openers can be purchased through Atom-Jet to weld on to replace broken and worn-out wings. Remember the designation of left and right wings based on the side of the drill shown earlier.

Hard Surfacing

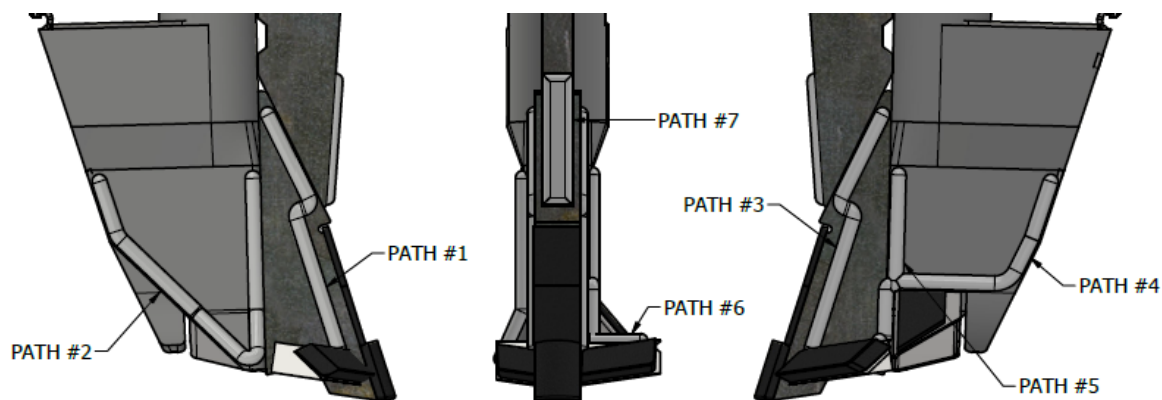

One of the reasons we chose steel to build our openers is the ease with which they can be maintained. The following steps are for re-building the hard surface weld beads:

- 1) Maintain the hard surfacing on the openers by building up the areas we have hard surfaced in the factory. Clean off the openers and work on at least ten openers at a time. The idea is to minimize the heat build-up in the opener, preventing any damage to the carbide.
- 2) Follow this order:
 - a. Starting $\frac{1}{8}$ " away from the carbide, do PATH #1 on all openers.
 - b. Next, do PATH #2 on the skirting of all openers. It may help to clamp a piece of steel inside the boot plate to give backing to the weld and to act as a heat sink.
 - c. Turn the openers over and do PATHS #3 to #5, following the same method as the first side.
 - d. Now, hold the opener so the wing is flat. Starting $\frac{1}{8}$ " from the carbide, do PATH #6.
 - e. Finally, hold the opener with the point facing up. Starting $\frac{1}{8}$ " from the carbide, do PATH #7.
- 3) Atom-Jet Industries regularly performs this process for many customers. Call today for a quote at 1-800-573-5048.